

说明: EEPROM电路

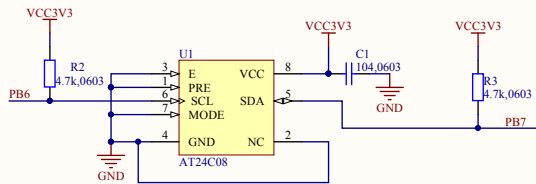

说明: USB通讯 & 系统供电

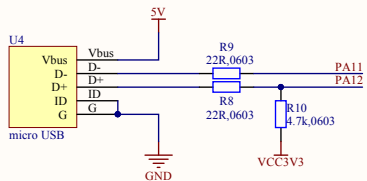

说明: 5V---->3.3V电路

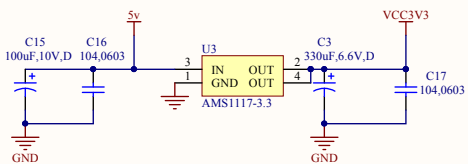

说明: 复位按键电路

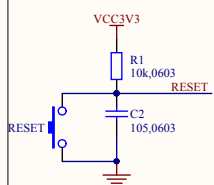

说明: Boot设置

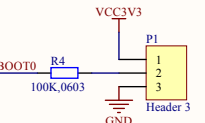

说明: LED灯

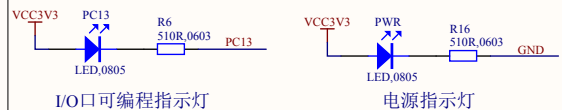

说明: 程序下载接口(SWD)

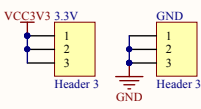
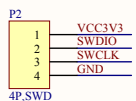

济南源地仪器设备有限公司

JiNan Yuandi Instrument Equipment Co.,Ltd

电话 : 0531-55561908

网站 : <http://www.vcc-gnd.com/>

淘宝店 : <http://vcc-gnd.taobao.com/>

说明: MCU--STM32F072RBT6

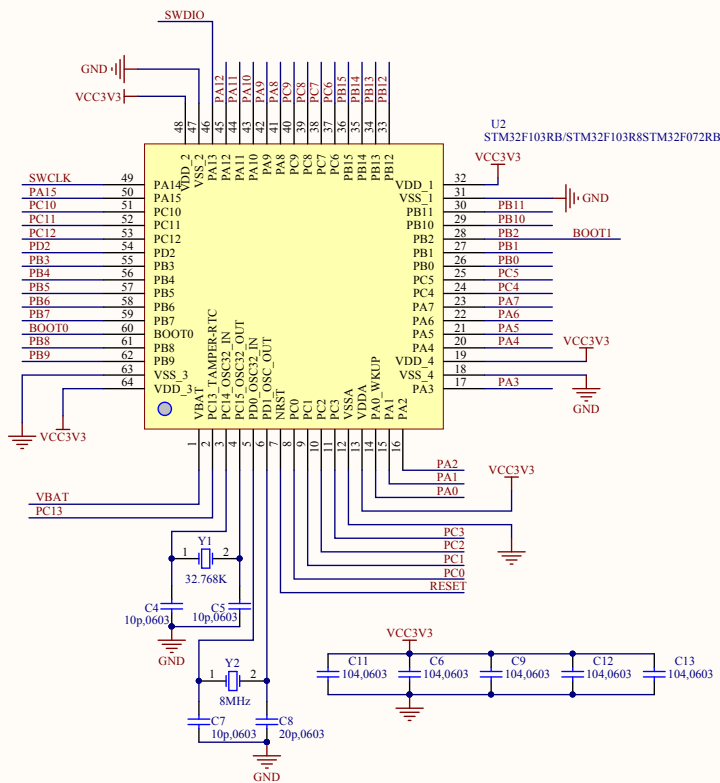

说明: I/O、电源连接排针

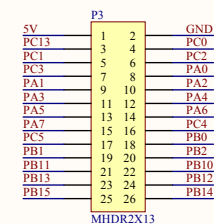
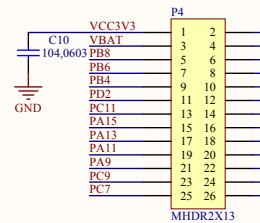

Title		
STM32F072RB核心板原理图		
Size	Number	Revision
A3	源地工作室www.vcc-gnd.com	
Date:	2017/4/28	Sheet of
File:	E:\工作\STM32F072RB最小系统SCL	Drawn By: