

BOOT1	BOOT0	MODE
X	0	FLASH
1	1	SRAM
0	1	ISP

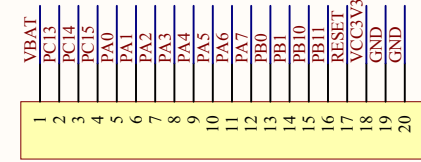

P1
Header 20

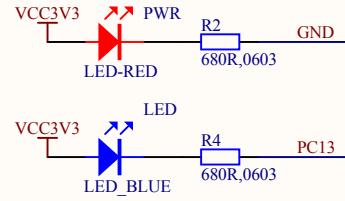

P2
Header 20

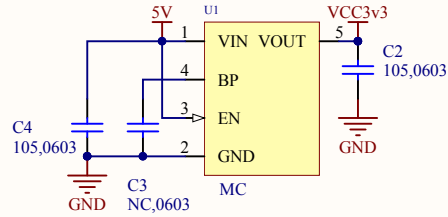

MCU

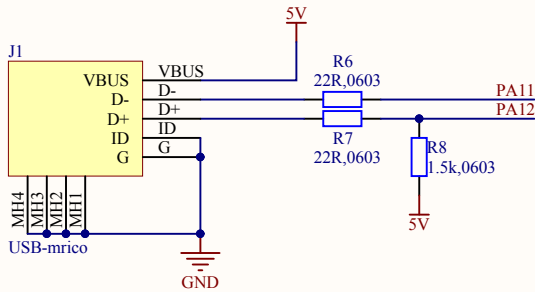
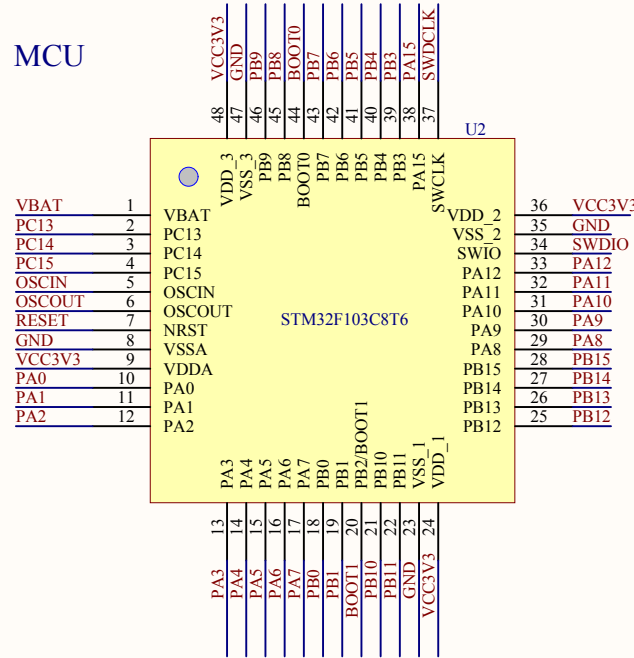

源地工作室<http://vcc-gnd.taobao.com/>

论坛地址：<http://www.vcc-gnd.com/>

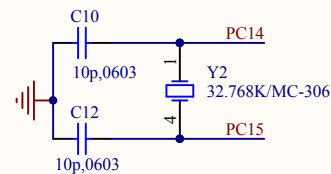
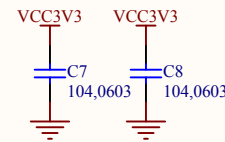
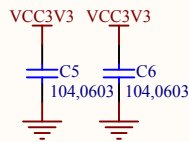
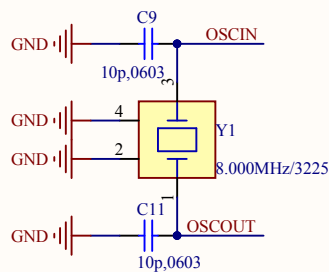
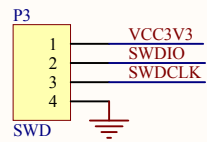
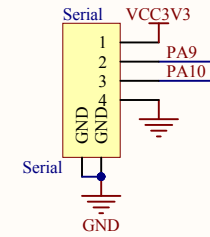

Title		
STM32F103C8T6核心板原理图		
Size	Number	Revision
A4	源地工作室www.vcc-gnd.com	
Date:	2019/1/2	Sheet of
File:	E:\工作\STM32F103C8T6.SchDoc	Drawn By: